

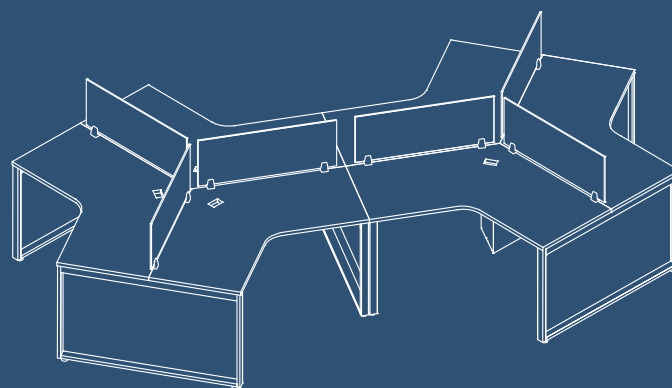

moetti.

# ENSAMBLA

FUNCIONAL · VERSÁTIL · LIGERA



OPERATIVOS.

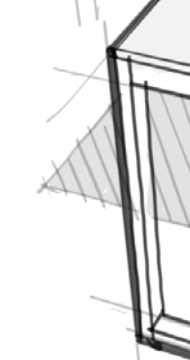
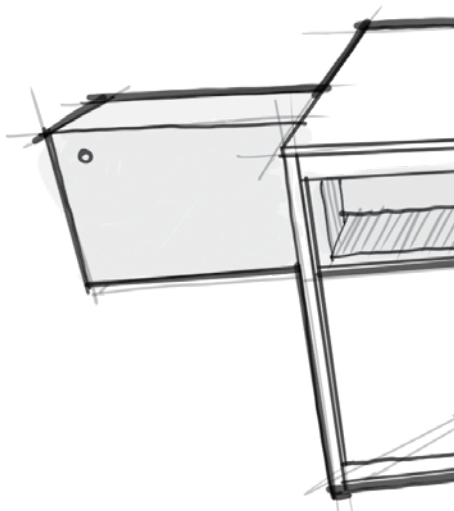

ENSAMBIA.

DIRECCIÓN.

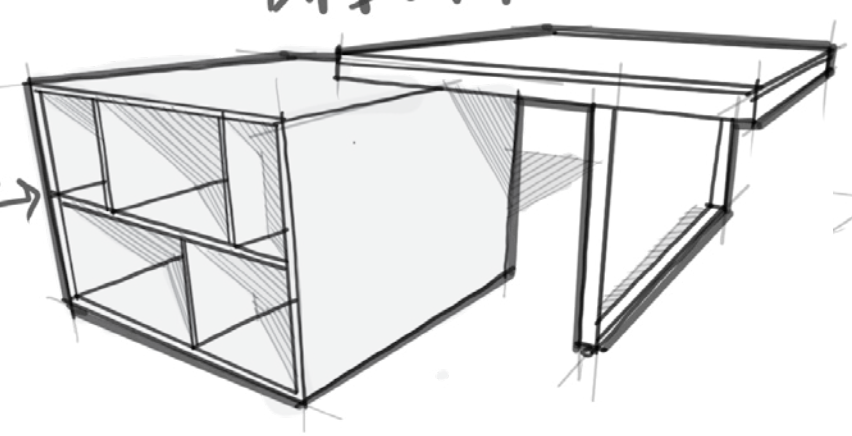

ELEMENTO DE GUARDADO DE AMBOS LADOS.

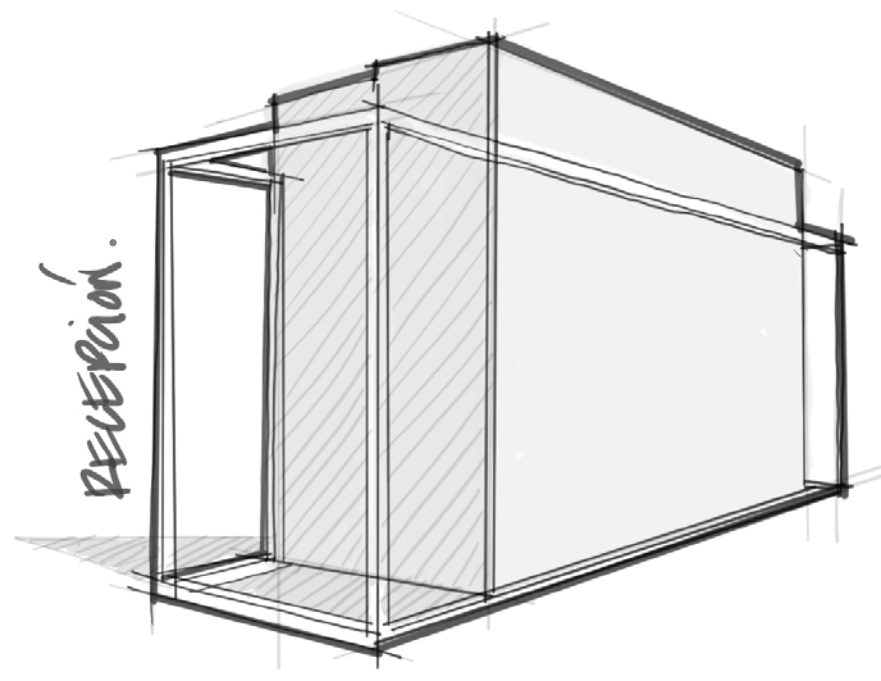

RECEPCIÓN.

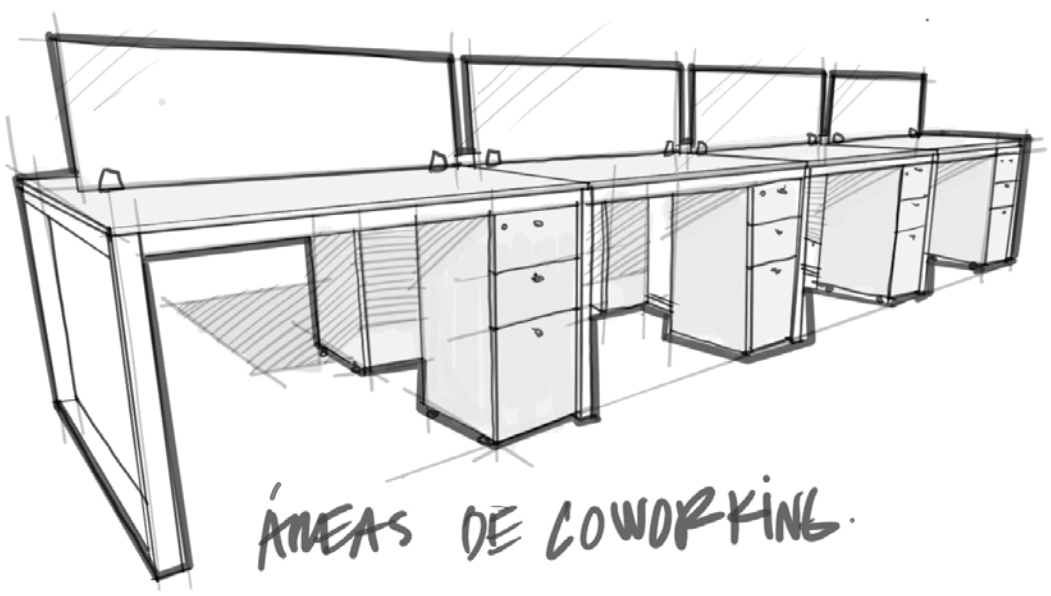

ÁREAS DE COWORKING.

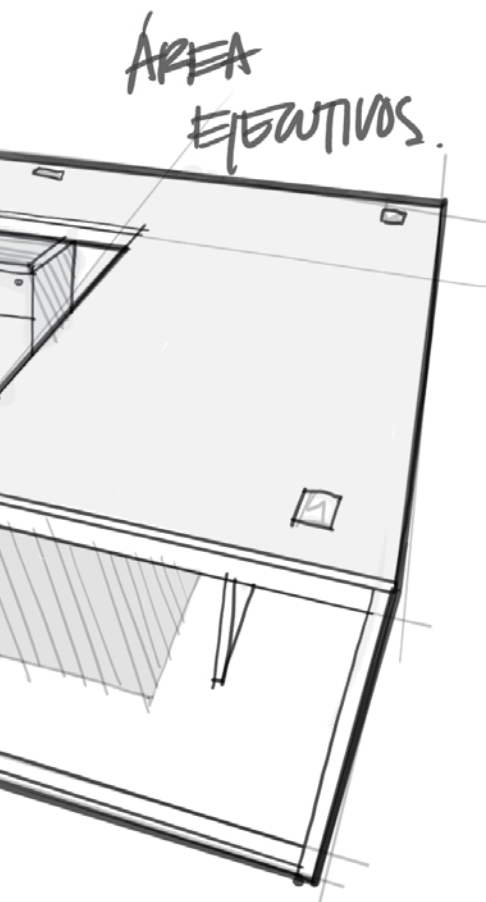
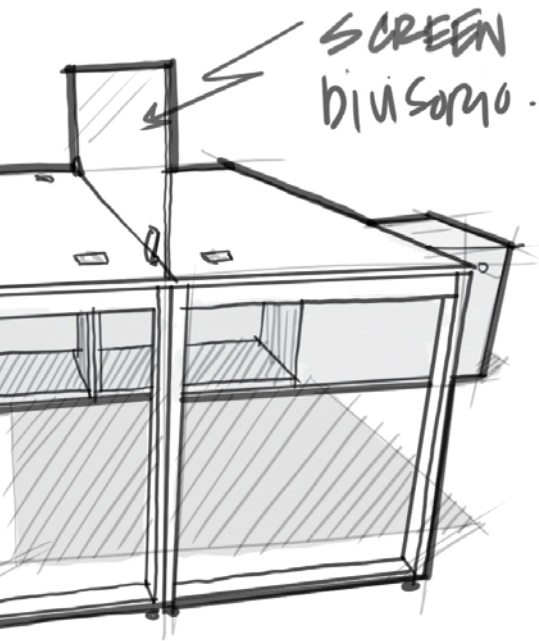

# CONTENIDO

- 04 RECEPCIÓN
  - 07 DIRECCIÓN
  - 08 EJECUTIVO
  - 11 OPERATIVO
  - 15 COWORKING
  - 18 SALA DE JUNTAS
  - 20 MESAS AJUSTABLES
  - 21 MESAS AUXILIARES
  - 26 MEDIDAS
  - 30 ACABADOS
-



## RECEPCIÓN

Módulo de recepción con estructura perimetral metálica en pintura electrostática con elementos de guardado.

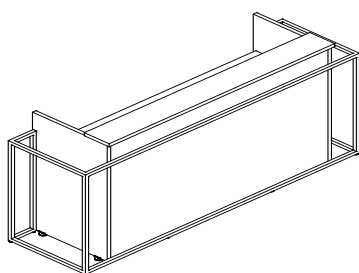
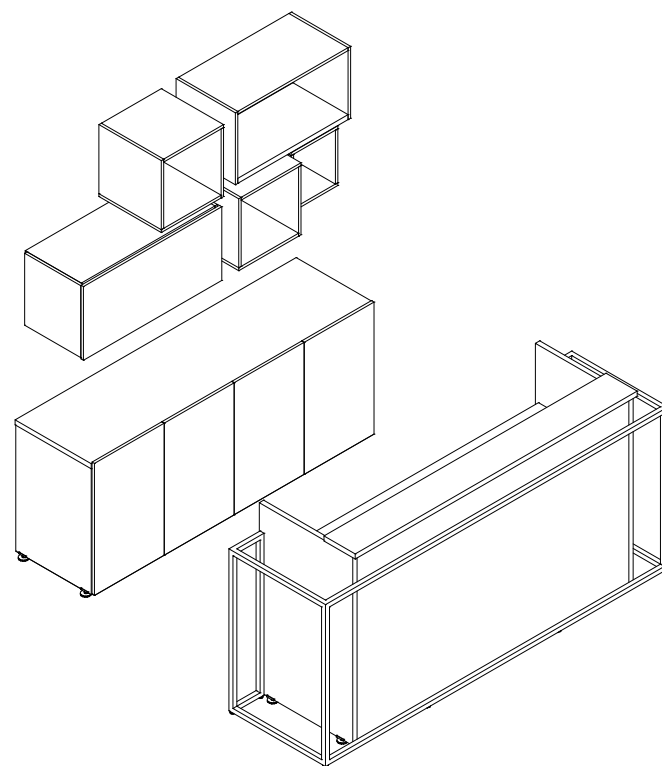
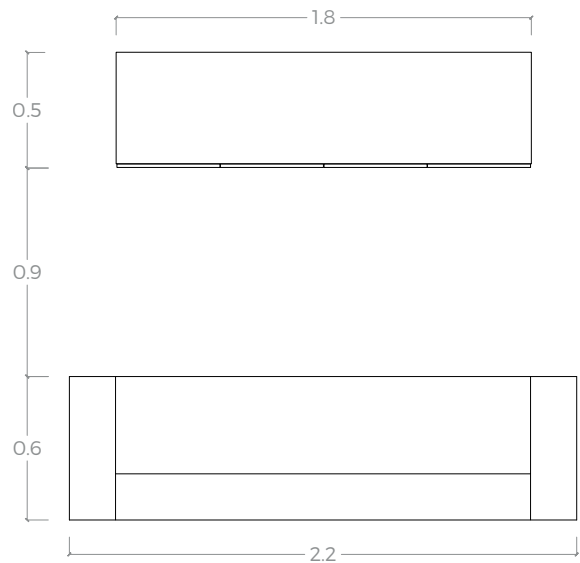

**MUEBLE DE RECEPCIÓN**  
 Encino Polar A3  
 Estructura metálica Gray Star

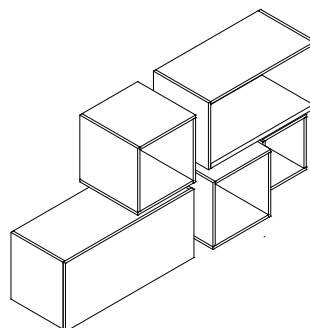

**GABINETES ABIERTOS  
 Y CON PUERTA**  
 Encino Polar A3  
 Frentes Agatha A2

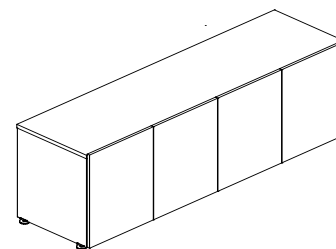

**CREDENZA CON PUERTAS**  
 1.80 x .50 x .75  
 Encino Polar A3  
 Frentes Agatha A2



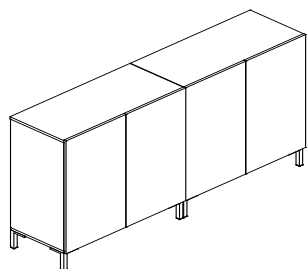

**LIBRERO CON PUERTAS**  
 Metropolitan A3  
 Frentes Agatha A2  
 Jaladera Niquelada J2  
 Patas Ivory

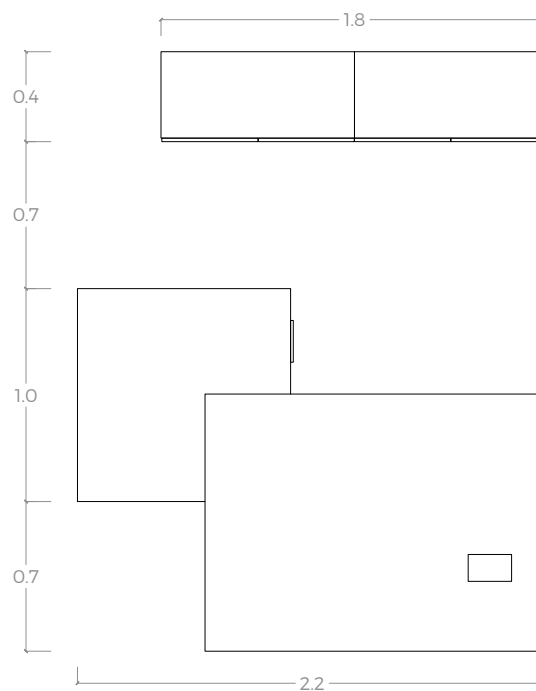

6

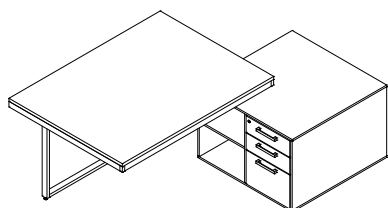

**CREDENZA BAJA**  
 Metropolitan A3  
 Frentes Agatha A2  
 Jaladera Niquelada J2

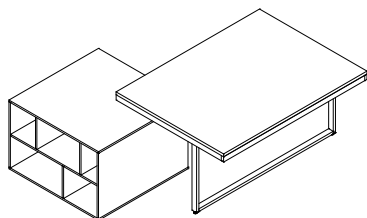

**ESCRITORIO**  
 Metropolitan A3  
 Estructura metálica Ivory





---

## DIRECCIÓN

Conjunto dirección con módulo de guardado bajo cubierta, incluye entrepaños a ambos lados y archivero 2 cajones + 1 gaveta (opcional).







## EJECUTIVO

Módulo ejecutivo en escuadra con archivero móvil de 1 cajón + 1 gaveta. Libreros con puerta y entrepaños.

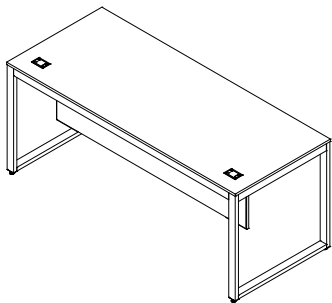
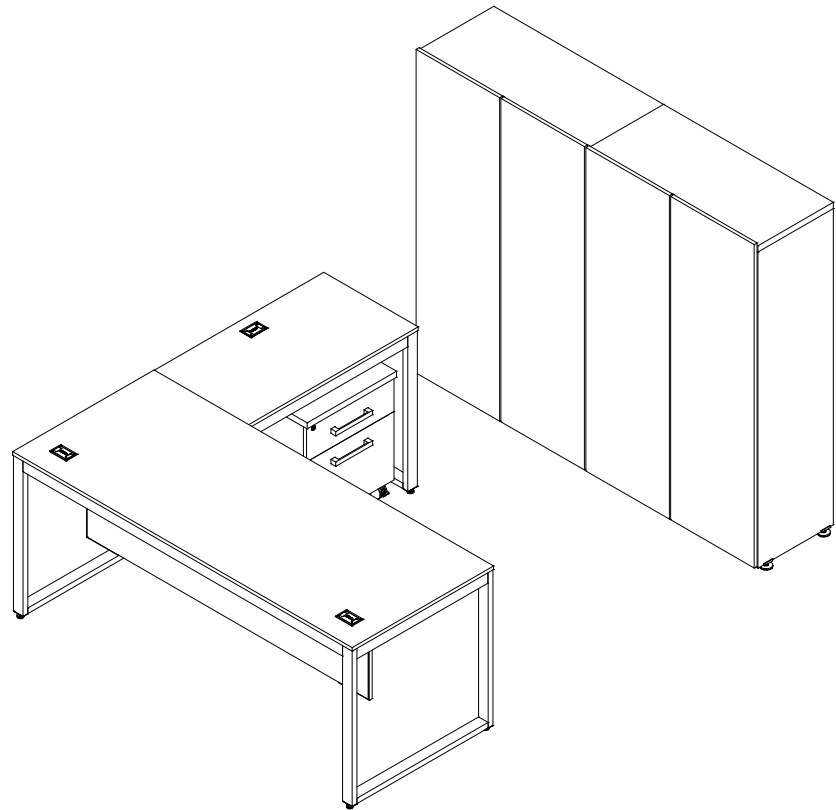
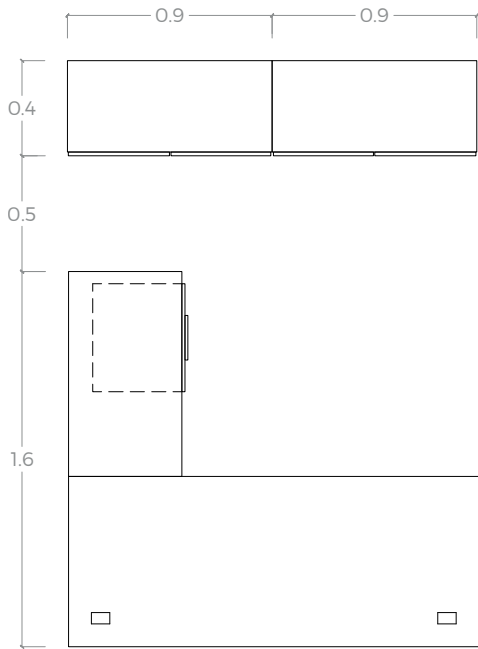

**ESCRITORIO CON FALDÓN**  
 Encino Polar A3  
 Estructura metálica Taupe  
 Grommet Taupe

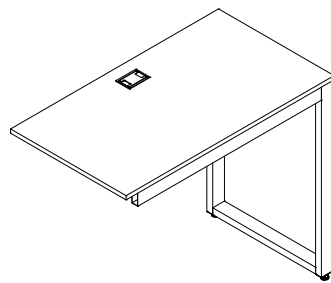

**LATERAL AUXILIAR**  
 Encino Polar A3  
 Estructura metálica Taupe  
 Grommet Taupe

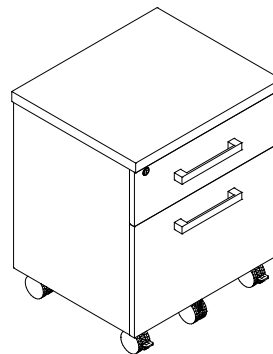

**ARCHIVERO MÓVIL**  
 1 cajón + 1 gaveta  
 Encino Polar A3  
 Rodaja Negra R1  
 Jaladera Niquelada J2

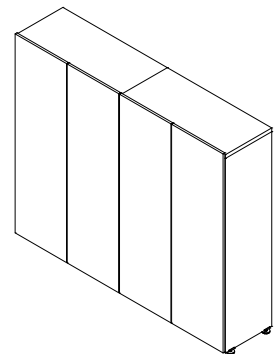

**LIBRERO CON PUERTAS**  
 Encino Polar A3  
 Acrílico Blanco Alto Brillo



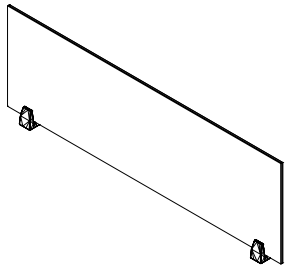

**SCREEN ACRÍLICO**  
Esmerilado Satinovo  
Clip Niquelado

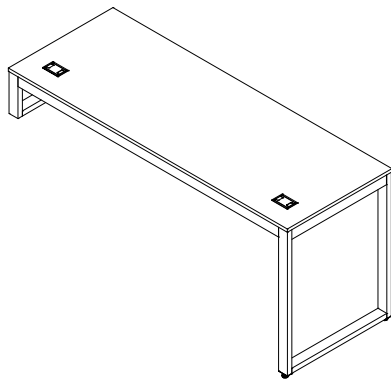

**ESCRITORIO**  
Laricina Siberia A2  
Estructura metálica Gray Star

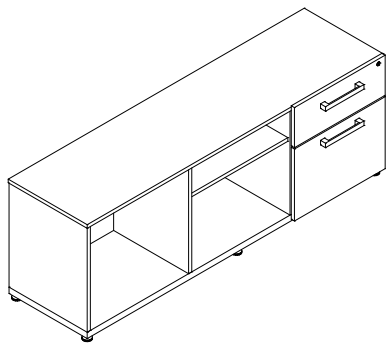

**TABURETE BAJO**  
Con áreas de guardado  
Laricina Siberia A2  
Frentes Azul Acero A2  
Jaladera Niquelada J2

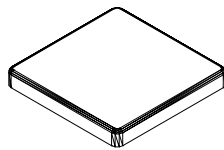

**COJÍN**  
Tela Grado 1  
Gris

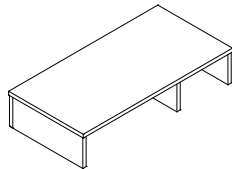

**REPISA PAPELERA**  
Azul Acero A2

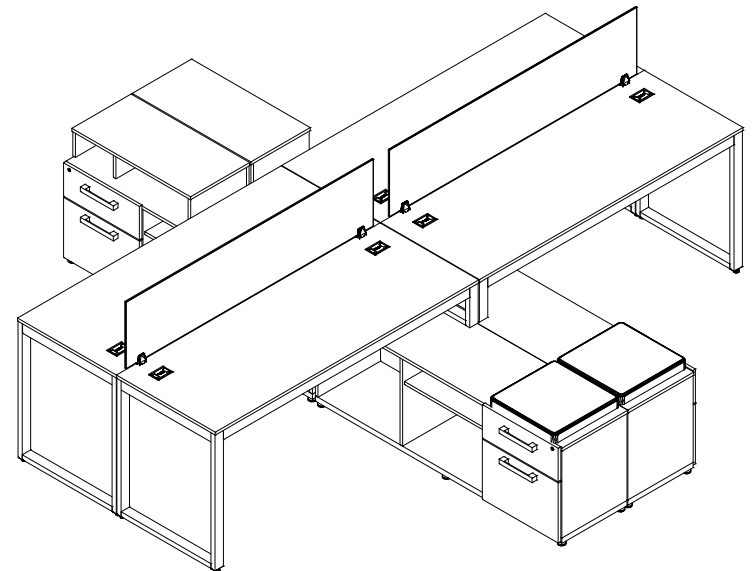
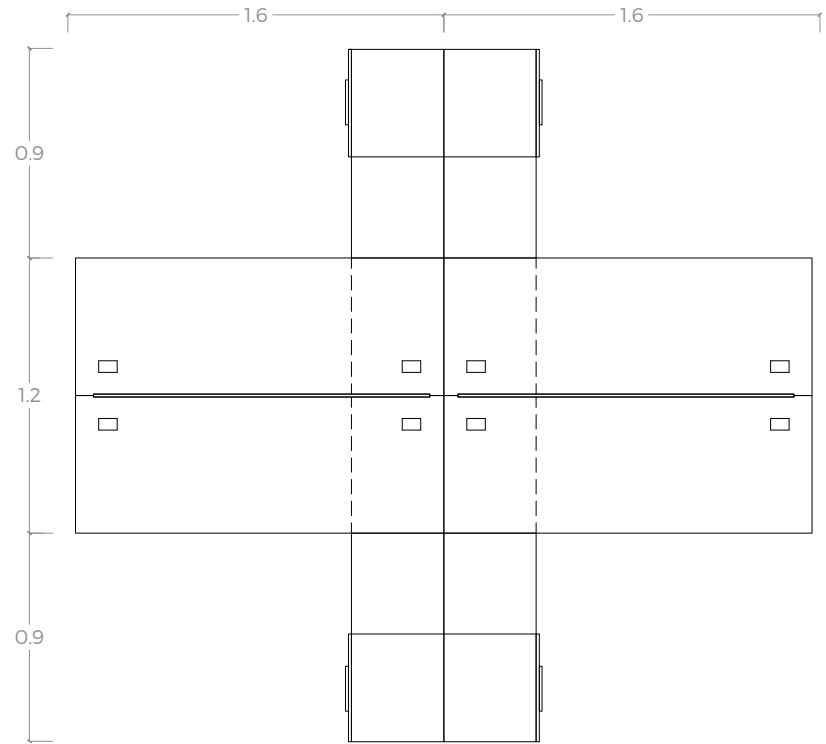



## OPERATIVO

Estación de trabajo para 4 usuarios con taburetes bajo escritorio de 1 cajón + 1 gaveta con áreas de guardado. Accesorios: repisa papelera, cojín tapizado sobre archivero y screen divisorio.





## OPERATIVO

---

Estación de trabajo para 4 usuarios con credenza bajo escritorios, incluye puerta corrediza. Accesorio: screen divisorio.

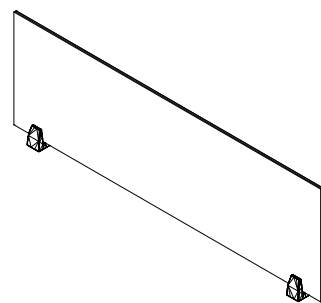

**SCREEN**  
Cristal de 4mm Azul Celeste  
Clip Niquelado

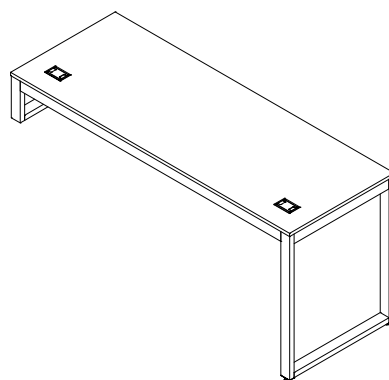

**ESCRITORIO**  
Blanco Frosty A1  
Estructura metálica Blanco Polar  
Grommet Blanco

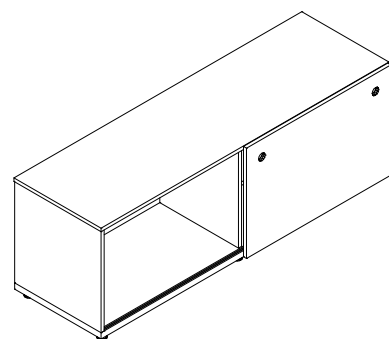
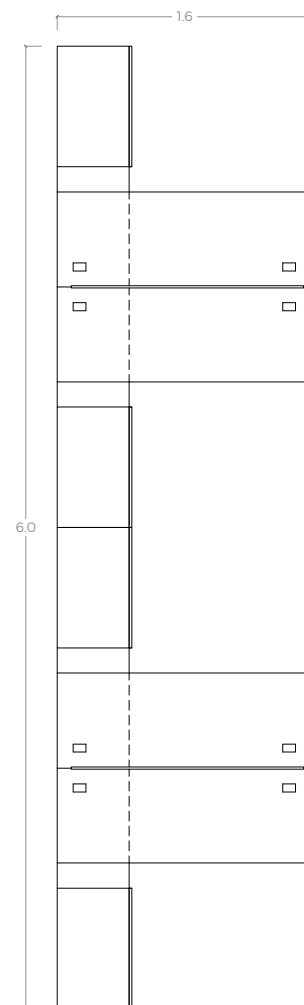

**CREENZA BAJA**  
Con puerta corrediza  
Encino Polar A3

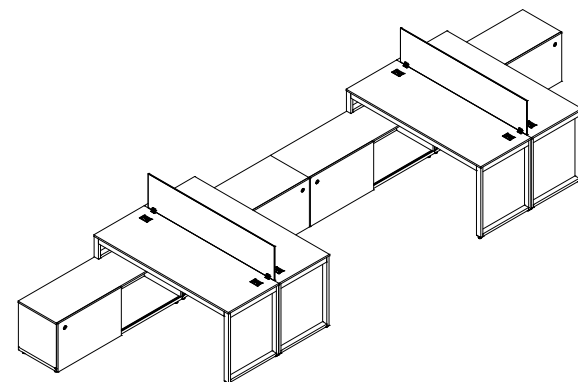

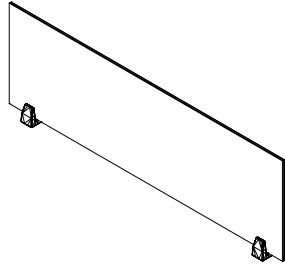

**SCREEN**  
Cristal de 4mm Azul Turquesa  
Clip Blanco Polar

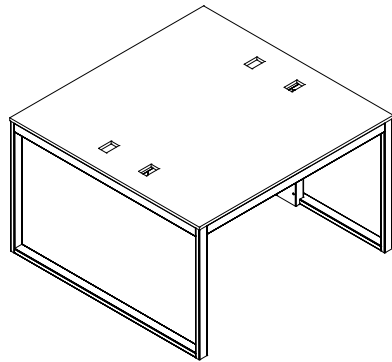

**MESA BENCH**  
Blanco Frosty A1  
Estructura metálica Blanco Polar  
PVC Acritrio Blanco

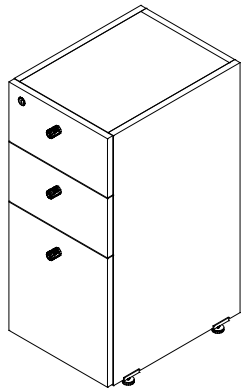

**ARCHIVERO**  
2 cajones + 1 gaveta  
Blanco Frosty A1  
Jaladera Botón Niquelada J6

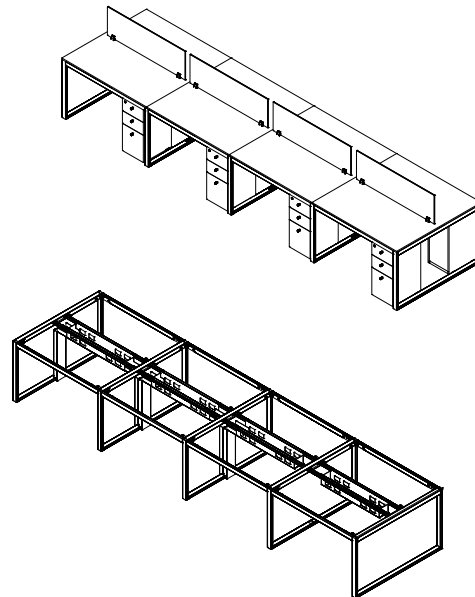
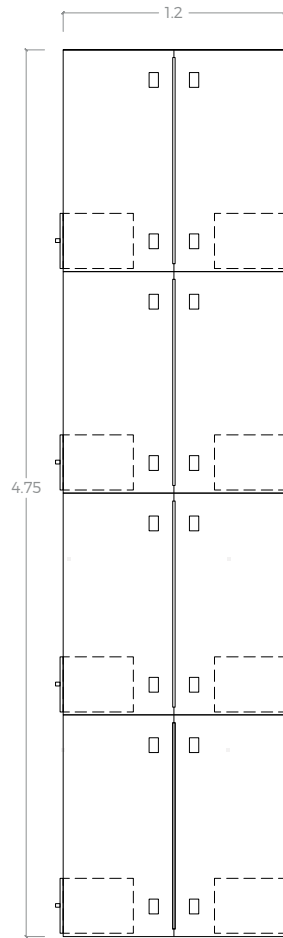



---

## COWORKING

Módulo de coworking de 8 usuarios con pedestal y canaletas electrificables, archivero de 2 cajones + 1 gaveta. Accesorio: screen divisorio.







## COWORKING

Módulo de coworking de 9 usuarios con pedestal y canaletas electrificables.  
Accesorio: screen divisorio.

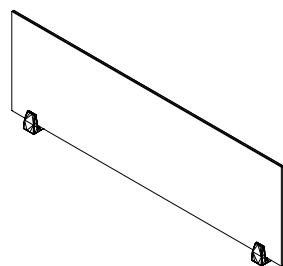
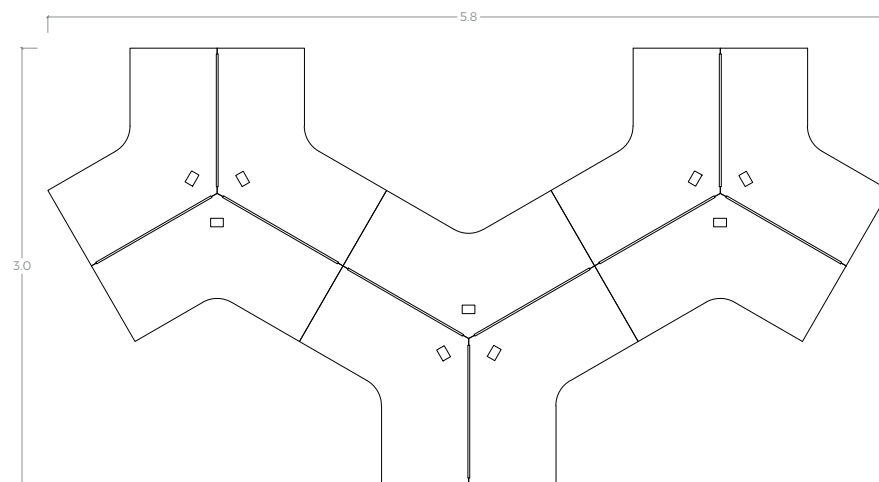

**SCREEN**  
Cristal de 4mm Café  
Clip Niquelado

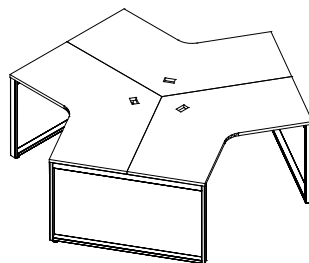
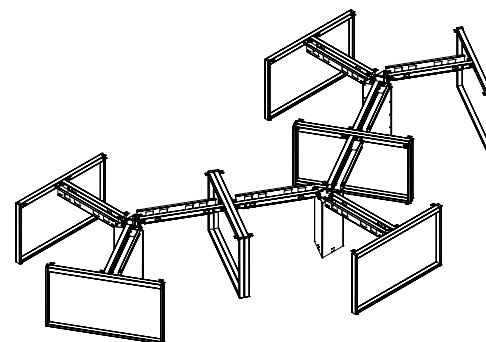

**TRICETA**  
Encino Polar A3  
Estructura metálica Taupe  
Grommet Blanco

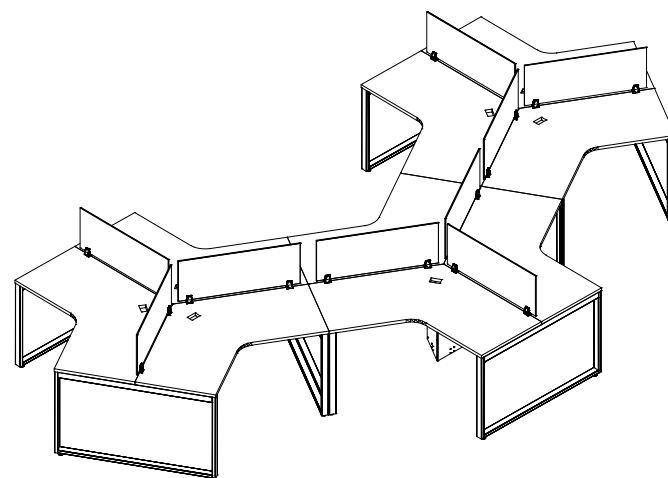



## SALA DE JUNTAS

Mesa de juntas para 8 o 10 usuarios, con cubiertas en cristal y centro en laminado plástico, preparado para recibir contactos electrificados (opcional). Credenza de 4 puertas.

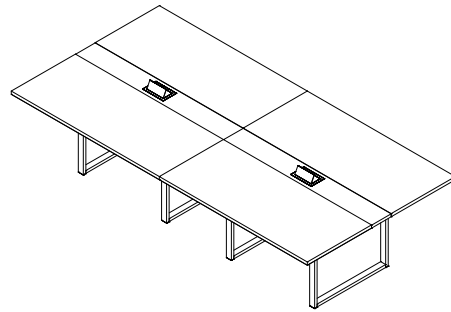

**MESA DE JUNTAS**  
 Encino Polar A3  
 Cristal Blanco  
 Estructura metálica Gray Star

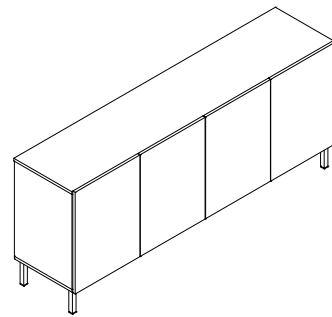
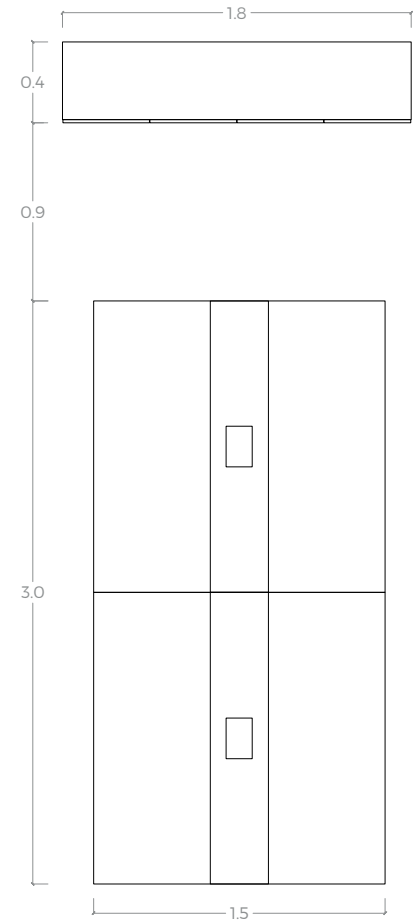

**CREDENZA CON PUERTAS**  
 1.80 x .40 x .75  
 Encino Polar A3  
 Frentes Acrilico Alto Brillo Blanco

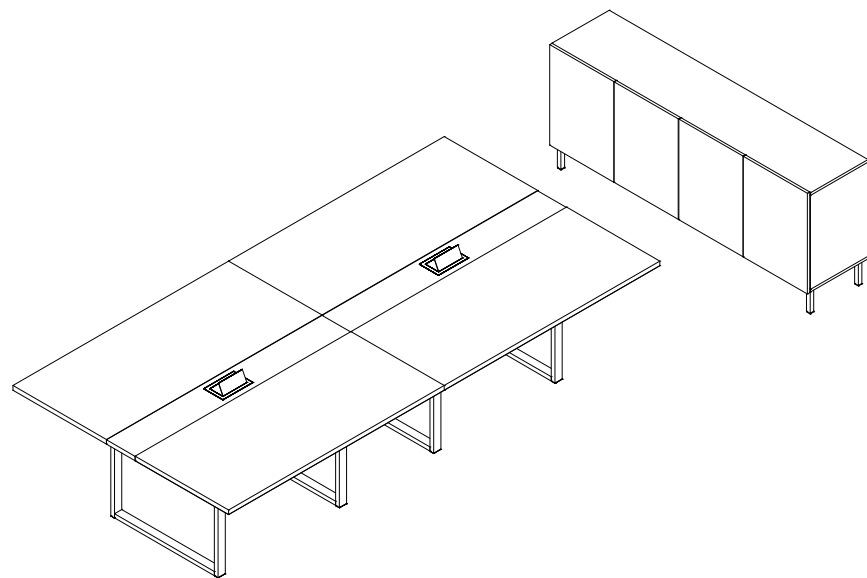

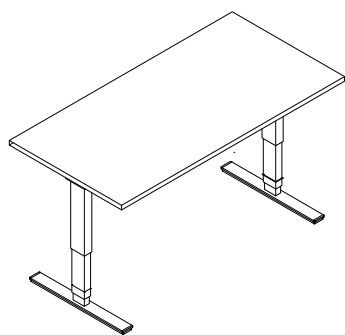

**OPCIÓN ACABADOS**  
A1, A2, A3 en 25 y 28mm.  
Estructura metálica Blanca,  
Gris y Negro.

## MESAS AJUSTABLES

Mesas de ajuste de altura variable con sistema eléctrico.

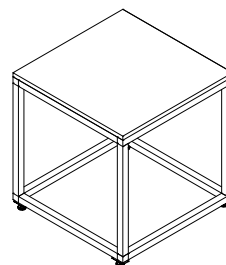

**MESA LATERAL**  
50 x 50 x 50  
Blanco Carrara A3  
Estructura metálica Grafito

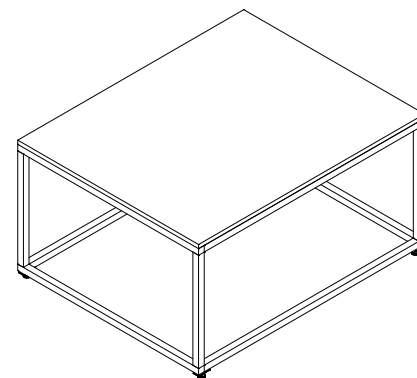

**MESA DE CENTRO**  
1.00 x 1.00 x 40  
Blanco Carrara A3  
Estructura metálica Grafito

## MESAS AUXILIARES



















# MEDIDAS

ESCRITORIOS  
FONDO DE 50

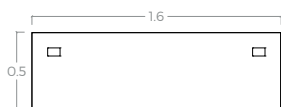
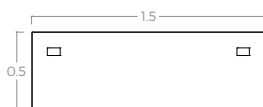
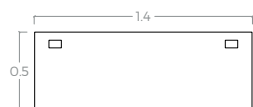
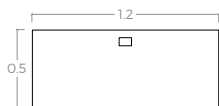
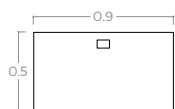
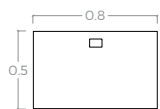

ESCRITORIOS  
FONDO DE 60

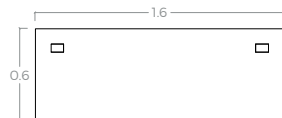
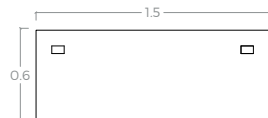
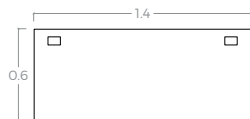
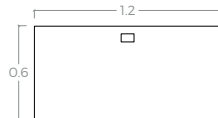
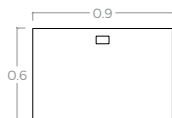
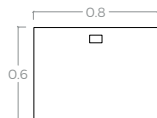

ESCRITORIOS  
FONDO DE 75

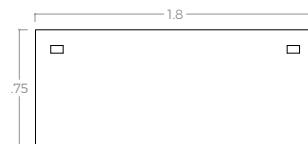
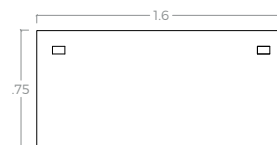
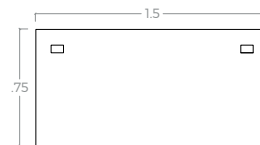

ESCRITORIO PATA  
COMBINADA FONDO DE 60

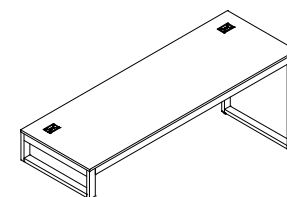
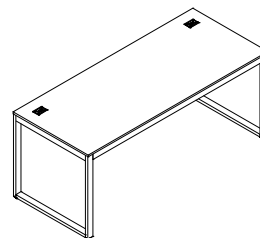
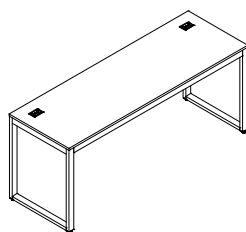
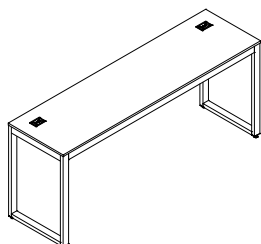
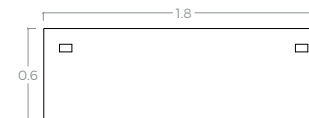
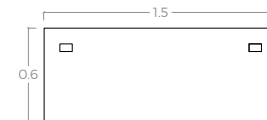



ESCRITORIO PATA  
COMBINADA FONDO DE 75

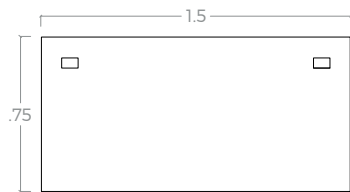

LATERAL  
FONDO DE 50

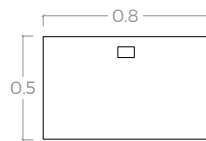

LATERAL  
FONDO DE .60

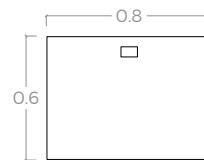

MESA BENCH 1.0

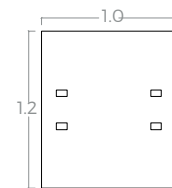

MESA BENCH 1.20

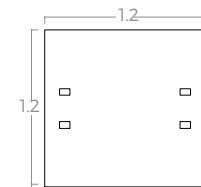

MESA BENCH 1.40

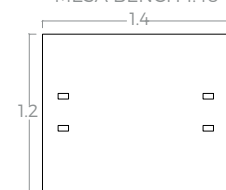

MESA BENCH 1.60

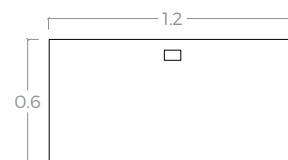
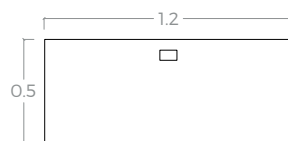
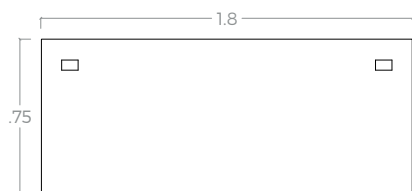
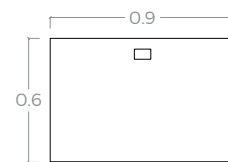
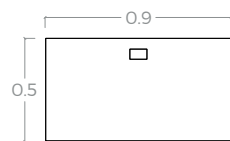
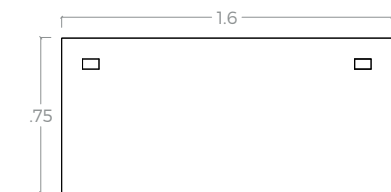
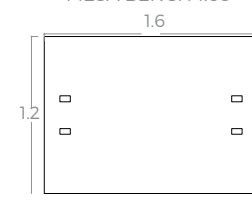

ACCESORIOS PARA  
ELECTRIFICACIÓN

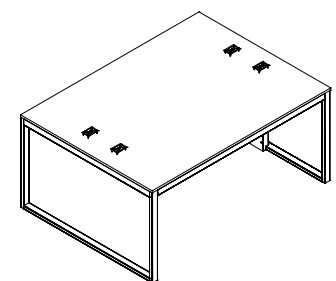
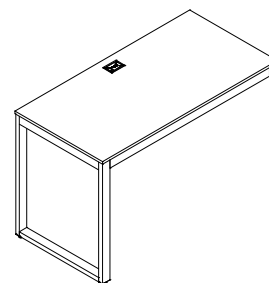
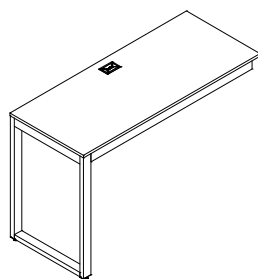
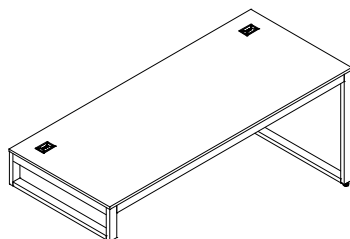
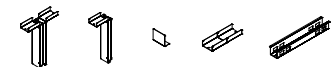

TRICETA DE 1.20

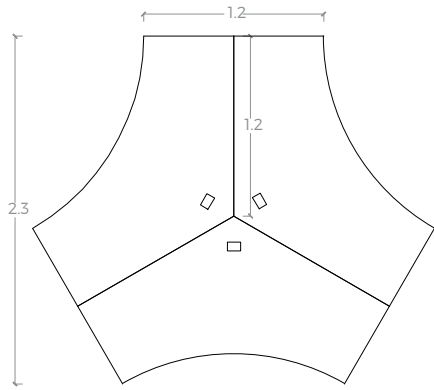

TRICETA DE 1.0

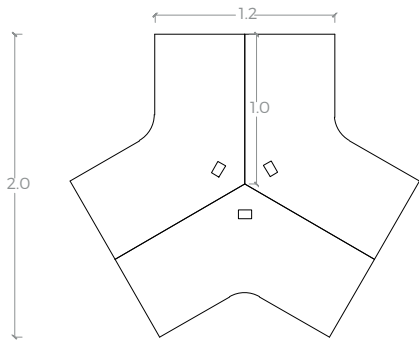

MESA DE JUNTAS  
CON CRISTAL

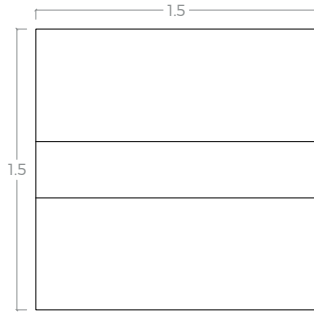
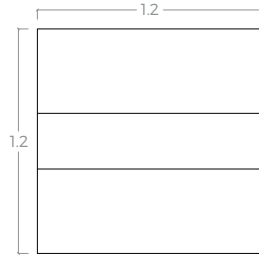

MESA DE JUNTAS

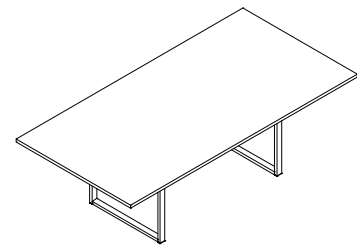
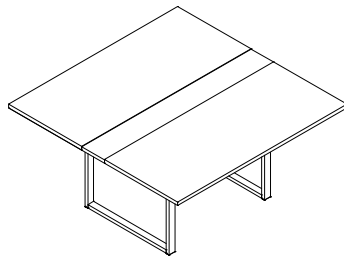
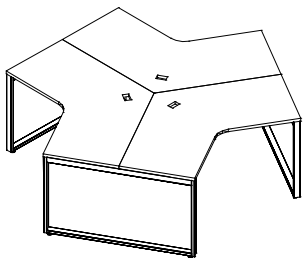
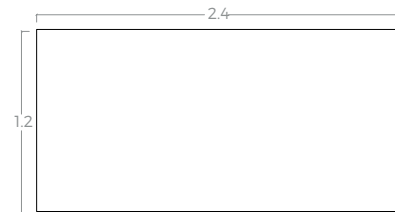
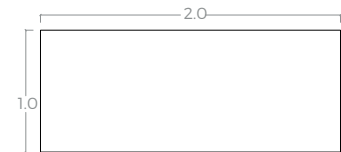
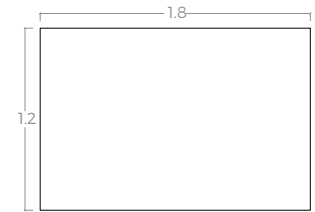
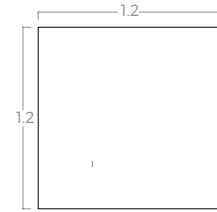
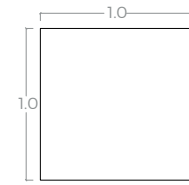

ESCRITORIO DIRECCIÓN

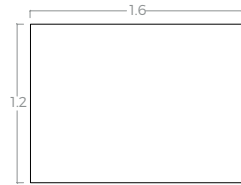
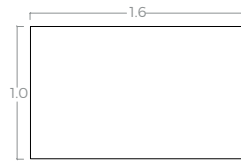

CUBO CON LIBRERO

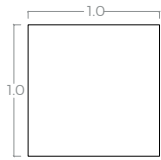

CUBO CON ARCHIVERO

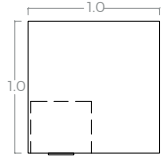

CUBO CON LIBRERO

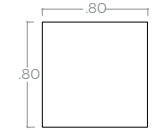

CUBO CON ARCHIVERO

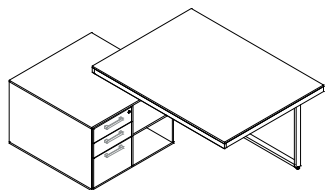
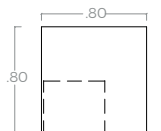

MESA DE ALTURA VARIABLE

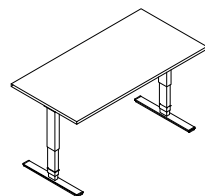
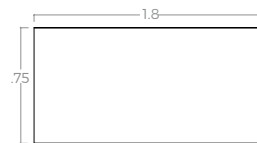
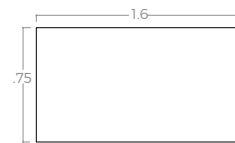
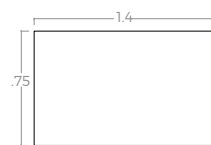
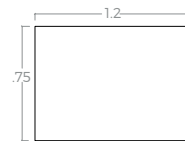
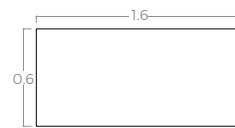
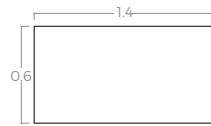
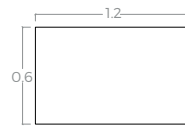

MESAS AUXILIARES

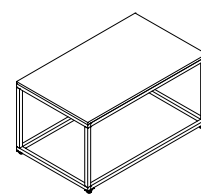
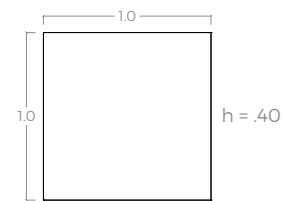
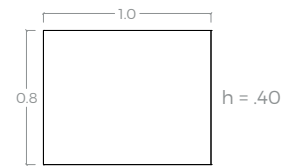
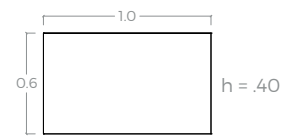
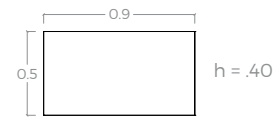
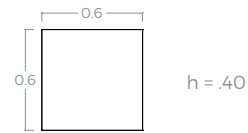
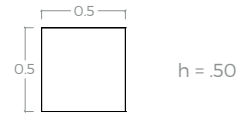

RECEPCIÓN

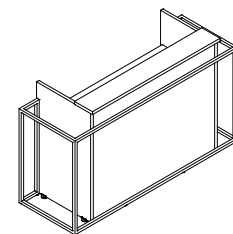
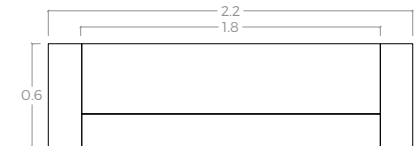
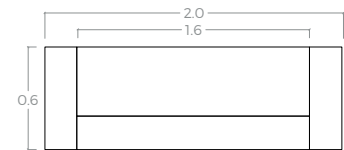
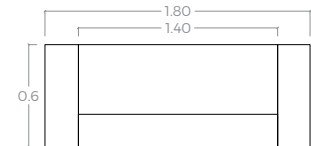
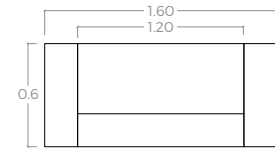

# ACABADOS

## | TABLEROS

MELAMINAS 16mm / 28mm | PVC

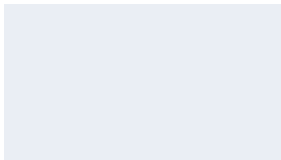

**A1** BLANCO FROSTY

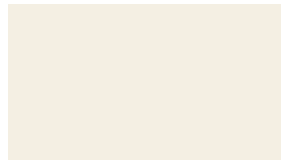

**A1** IVORY



**A2** GRIS



**A2** VISÓN



**A2** OXFORD

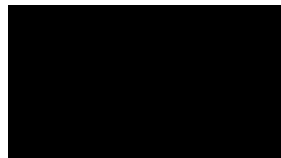

**A2** NEGRO



**A2** AGATHA



**A2** AZUL ACERO



**A2** LARICINA SIBERIA

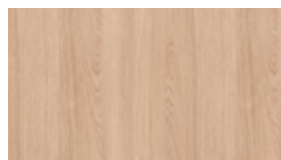

**A2** ROBLE MÉRIDA



**A2** NOGAL URBANO



**A2** PRECOMPUESTO CENIZA

## MDF FENIX (HPL) / PVC



BLANCO MATE

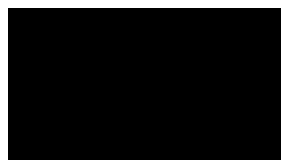

NEGRO MATE



**A3** ENCINO POLAR



**A3** DURANGO



**A3** METROPOLITAN



**A3** NEBRASKA

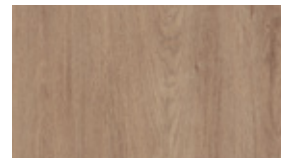

**A3** MONARCA



**A3** FRESNO BRUMA



**A3** ROBLE SANTANA

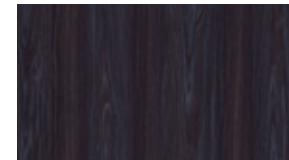

**A3** ANÁHUAC

## MDF / MELÁNICO / PVC

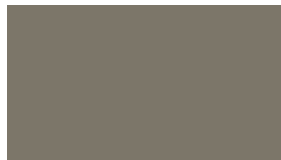

**A3** GRIS METEORO

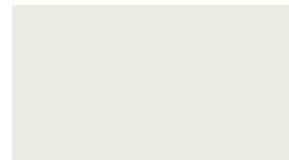

**A3** BLANCO CÁLIDO

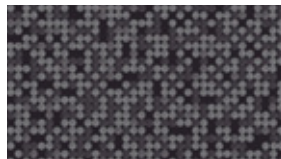

**A3** PIX NEGRO



**A3** PIX BLANCO



**A3** BLANCO CARRARA

| TABLEROS  
MDF ACRÍLCOS (MATE Y ALTO BRILLO) / PVC

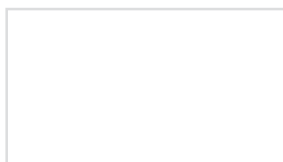

BLANCO



GRIS



ANTRACITA

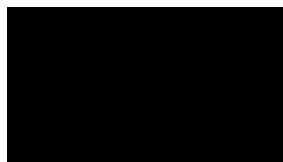

NEGRO



CURRY (SOLO ALTO BRILLO)

MDF / FOIL



CRETA

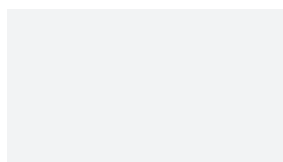

PERLA

| PINTURA ELECTROESTÁTICA

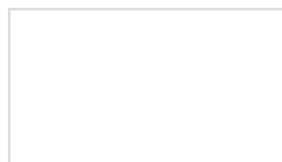

BLANCO POLAR

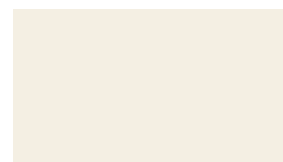

IVORY



TAUPE

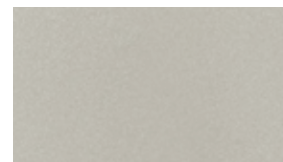

GRAY STAR

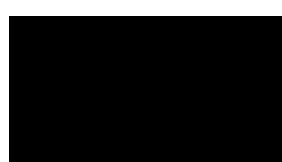

NEGRO



GRAFITO

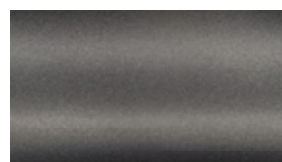

SILVER



CROMO

PVC / ACRÍLICO ACRITRIO



BLANCO



GRIS



ANTRACITA

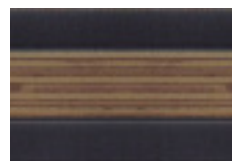

NEGRO

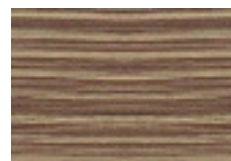

TRIPLAY MARINO



BLANCO ALUMINIO



## SCREEN DE CRISTAL

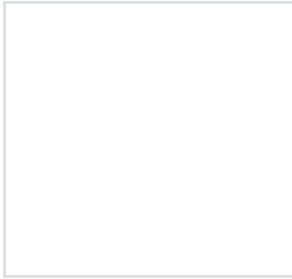

BLANCO

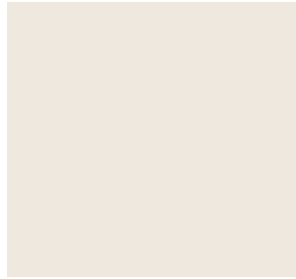

IVORY



GRIS



CAFE



NEGRO



AMARILLO



MANGO



TEJOCOTE



ROJO CHINO



VINO



VERDE



ROMERO

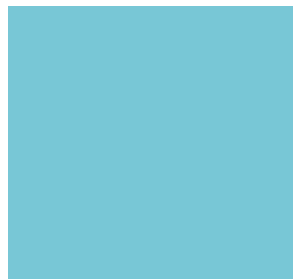

AZUL TURQUESA



AZUL CELESTE



AZUL FUERTE

32

## SCREEN ACRILICO

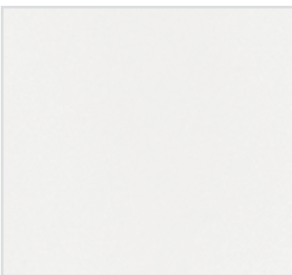

SATINOVO



RECEPCIÓN



DIRECCIÓN



EJECUTIVO



OPERATIVO



OPERATIVO



COWORKING



COWORKING



SALA DE JUNTAS



MESAS AJUSTABLES



MESAS AUXILIARES

## SALA DE EXHIBICIÓN CULIACÁN

A. Obregón #1106, Local 2  
Edificio María Fernanda, Col. Guadalupe  
Col. Guadalupe, Culiacán, Sin.

 (667) 1476748 / (667) 712 6170  
(667) 712 6173 / (667) 712 6174  
(667) 764 4592



**SALA DE EXHIBICIÓN LOS MOCHIS**  
Av. Venustiano Carranza #327, entre I. Zaragoza  
y G. Leyva, Col. Centro, Los Mochis, Sinaloa.

 (668) 8187835 / (668) 688 6190

 **moetti**<sup>®</sup>  
ESPACIOS INFINITOS

[www.moetti.com](http://www.moetti.com)